

# PJL Open Frame Power Supply

## 48 V 400 W 1 Phase / PJL-48V400WBAA

# PJL

### Highlights & Features

- Universal AC input voltage range
- 400W with fan cool and up to 200W convection cool
- Standard industrial footprint of 3" x 5"
- Low inrush current < 20A and up to 90.0% efficiency
- Conforms to harmonic current IEC/EN 61000-3-2, Class C
- Low earth leakage current < 500µA
- Extreme low temperature operation at -40°C
- Lighting approval to UL 8750, IEC 61347-2-13 and others approval to IEC/EN/UL 60950-1, IEC/EN/UL 62368-1

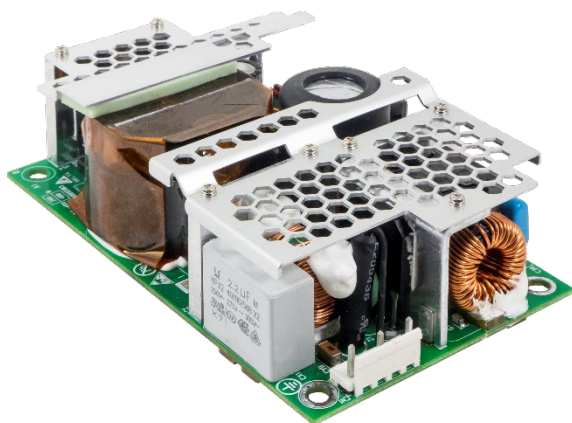

### Safety Standards



CB Certified for worldwide use

<b>Model Number:</b>	PJL-48V400WBAA
<b>Unit Weight:</b>	0.44 kg (0.97 lb)
<b>Dimensions (L x W x D):</b>	127 x 76.6 x 39.3 mm (5.00 x 3.02 x 1.55 inch)

### General Description

The PjL-48V400WBAA comes with a + 48 V nominal main output. The open frame power supply is designed with small standard industrial 3" x 5" footprint for lighting application. The highly efficient fan cool and convection cooled design with optimum thermal management for high power efficiency. The product can operate from -40°C to +80°C across the entire input voltage range of 85 to 305 Vac and features low earth leakage current as well as low inrush current. The built-in active PFC product has safety approval for lighting application according to UL 8750, IEC 61347-2-13 and major international safety standard according to IEC 60950-1, IEC 62368-1 and is certified for EMI standards according to EN/BS EN 55032 Class B.

### Model Information

PJL Open Frame Power Supply

Model Number	Input Voltage Range	Rated Output Voltage	Rated Output Current
PJL-48V400WBAA	85-305 Vac	48 Vdc	8.33 A

### Model Numbering

PJ	L –	48 V	400 W	B	A	A
Open Frame	Product Type L – Lighting Application Series	Output Voltage	Output Power	Package Type B – Open Frame	Active PFC	TE connector

# PJL Open Frame Power Supply

## 48 V 400 W 1 Phase / PJL-48V400WBAA

### Specifications

#### Input Ratings / Characteristics

Nominal Input Voltage	100-277 Vac	
Input Voltage Range*	85-305 Vac	
Nominal Input Frequency	50-60 Hz	
Input Frequency Range	47-63 Hz	
Input Current	< 4.74 A @ 115 Vac	
Efficiency	100% load	> 85% @ 115 Vac, > 90% @ 230 Vac
	20% load	> 85% @ 115 Vac, > 85% @ 230 Vac
Max Power Dissipation	No Load	< 0.7 W @ 230 Vac
	100% Load	< 44.5 W @ 230 Vac
Max Inrush Current (Cold Start)	< 20 A @ 230 Vac	
Power Factor	75-100% load	> 0.95 @ 115 Vac & 230
	50% load	> 0.83 @ 115 Vac & 230
	25% load	> 0.65 @ 115 Vac & 230
Earth Leakage Current (Touch Current)	< 500 $\mu$ A	According to CSA C22.2 No. 166 and UL8750 edition 2 <sup>nd</sup>

\*For power de-rating at 85-100Vac, see power de-rating on page 3.

#### Output Ratings / Characteristics\*\*

Nominal Output Voltage	48 Vdc	
Factory Set Point Tolerance	48 Vdc $\pm$ 1%	
Output Voltage Adjustment Range	48-50 Vdc	
Output Current	8.33 A (400 W Max.)	
Output Power	400 W	Vout is in regulation until no load
Operation Mode	Constant Voltage	From no load to maximum load
Line Regulation	$\pm$ 1.0% (@ 100-277 Vac input, 100% load)	
Load Regulation	$\pm$ 2.0% (@ 100-277 Vac input, 0-100% load)	
PARD*** (20MHz)	< 680	20 MHz, warm up for 10mins
Rise Time	< 100 ms @ nominal input (100% load)	
Start-up Time	< 500 ms @ 100 Vac & 240 Vac (100% load)	With and without capacitive loads
Hold-up Time	> 5 ms @ 115 Vac & 230 Vac (100% load)	
Dynamic Response (Overshoot & Undershoot O/P Voltage)	$\pm$ 5% @ 100-305 Vac input, 0-50% load & 50-100% load & 0-100% load (Slew Rate: 2.5 A/ $\mu$ S, 50% duty cycle @ 5 Hz, 50 Hz, 1 KHz)	
Start-up with Capacitive Loads	680 $\mu$ F	

\*\*For power de-rating from 50°C to 80°C, see power de-rating on page 3.

\*\*\*PARD is measured with an AC coupling mode, 5cm wires, and in parallel with 0.1 $\mu$ F ceramic capacitor & 47 $\mu$ F electrolytic capacitor.

# PJL Open Frame Power Supply

## 48 V 400 W 1 Phase / PJL-48V400WBAA

### Mechanical

Dimensions (L x W x D)	127 x 76.6 x 39.3 mm (5.00 x 3.02 x 1.55 inch)	
Unit Weight	0.44 kg (0.97 lb)	
Cooling System	Convection	0-200 W
	Fan Cool	201-400 W With 400 LFM fan cool, 15mm distance between PSU and fan
Power Supply Header	Input (CN1)	1-1123724-3
	Output (CN2)	1-1123723-4
Wire	Input (CN1)	AWG 18
	Output (CN2)	AWG 18
Noise (1 Meter from power supply)	Sound Pressure Level (SPL) < 25 dBA	

### Environment

Surrounding Air Temperature	Operating	-40°C to +80°C
	Storage	-40°C to +85°C
Power De-rating	Temperature (Convection)	Refer to Output Load De-rating VS Surrounding Air Temperature Fig.1 on Page 8
	Temperature (Fan Cool)	> 50°C de-rate power by 5 W / °C > 70°C de-rate power by 10 W / °C (400 W @ 50°C, 350 W @ 60°C, 300 W @ 70°C, 200 W @ 80°C with 400 LFM fan cool)
	Input Voltage	< 100Vac de-rate power by 1.33% / Vac (80% load at 85Vac)
	Cold Temperature	< -20°C de-rate power by 4 W / °C (80% load at -40°C)
Operating and Storage Humidity	5 to 95% RH (Non-Condensing)	
Operating Altitude	0 to 5,000 Meters (16,400 ft.)	
Shock Test	Non-Operating	IEC 60068-2-27, Half Sine 50 G for a duration of 11 ms, 3 times per direction, 9 times in total
Vibration	Operating	IEC 60068-2-6, 10 Hz to 150 Hz @ 25 m/S <sup>2</sup> (2.5 G peak); displacement of 0.35 mm; 90 min per axis for all X, Y, Z direction
Over Voltage Category	II	
Pollution Degree	2	

### Protections

Output Overvoltage	< 60 V, SELV Output, Latch Mode
Input Under Voltage	Brownout & Brownout Recovery protection
Overload / Overcurrent	> 105% of rated load current, Hiccup mode, Non-Latching (Auto recovery)
Over Temperature	Latch Mode
Short Circuit	Hiccup Mode, Non-Latching (Auto-Recovery when the fault is removed)
Internal Fuse at L pin	T6.3AH
Protection Against Shock	Class I with PE* connection

\*PE: Primary Earth

# PJL Open Frame Power Supply

## 48 V 400 W 1 Phase / PJL-48V400WBAA

### Reliability Data

MTBF	> 500,000 hrs. as per Telcordia SR-332 I/P: 115 Vac, O/P: 100% load, Ta: 25°C
Expected Cap Life Time	10 years (115 Vac & 230 Vac, 50% load @ 40°C)

### Safety Standards / Directives

Safety Entry Low Voltage		SELV ((IEC 60950-1)
Electrical Safety	SIQ Bauart	EN 62368-1
	cCSAus	CSA C22.2 No. 250.13 and UL 8750 CSA C22.2 No. 60950-1 and UL 60950-1 CSA C22.2 No. 62368-1 and UL 62368-1
	CB scheme	IEC 60950-1, IEC 62368-1, IEC 61347-1 and IEC 61347-2-13
CE		In conformance with EMC Directive 2014/30/EU and Low Voltage Directive 2014/35/EU
UKCA		In conformance with Electromagnetic Compatibility Regulations 2016 and Electrical Equipment (Safety) Regulations 2016
Galvanic Isolation	Input to Output	4 kVac (Reinforced) 3 kVac (Production Test)
	Input to Ground	1.5 kVac (Basic & Production Test)
	Output to Ground	1.5 kVac (Basic)
Isolation Resistance	Input to Output	> 100 MOhm
PE Resistance		< 0.1 Ohm

### EMC

Emissions (CE & RE)		Generic Standards: CISPR 32, EN/BS EN 55032: Class B
Immunity		Generic Standards: EN/BS EN 55024, EN/BS EN 55035
Electrostatic Discharge	IEC 61000-4-2	Level 3 Criteria A <sup>1)</sup> Air Discharge: 8 kV Contact Discharge: 6 kV
Radiated Field	IEC 61000-4-3	Level 3 Criteria A <sup>1)</sup> 80 MHz-1 GHz, 10 V/M, 80% modulation (1 kHz)
Electrical Fast Transient / Burst	IEC 61000-4-4	Level 3 Criteria A <sup>1)</sup> 2 kV (Input power ports)
Surge	IEC 61000-4-5	Level 3 Criteria A <sup>1)</sup> Common Mode <sup>3)</sup> : 2 kV Differential Mode <sup>4)</sup> : 1 kV
Conducted	IEC 61000-4-6	Level 3 Criteria A <sup>1)</sup> 150 kHz-80 MHz, 10 Vrms
Power Frequency Magnetic Fields	IEC 61000-4-8	Criteria A <sup>1)</sup> 10 A/Meter
Voltage Dips and Interruptions	IEC 61000-4-11	100% dip; 1 cycle (20 ms); Self Recoverable
Low Energy Pulse Test (Ring Wave)	IEC 61000-4-12	Level 3 Criteria A <sup>1)</sup> Common Mode <sup>3)</sup> : 2 kV Differential Mode <sup>4)</sup> : 1 kV
Harmonic Current Emission		IEC/EN/BS EN 61000-3-2, Class C
Voltage Fluctuation and Flicker		IEC/EN/BS EN 61000-3-3 at nominal voltages and full

1) Criteria A: Normal performance within the specification limits

2) Criteria B: Temporary degradation or loss of function which is self-recoverable

3) Asymmetrical: Common mode (Line to earth)

4) Symmetrical: Differential mode (Line to line)

# PJL Open Frame Power Supply

## 48 V 400 W 1 Phase / PJL-48V400WBAA

### Block Diagram

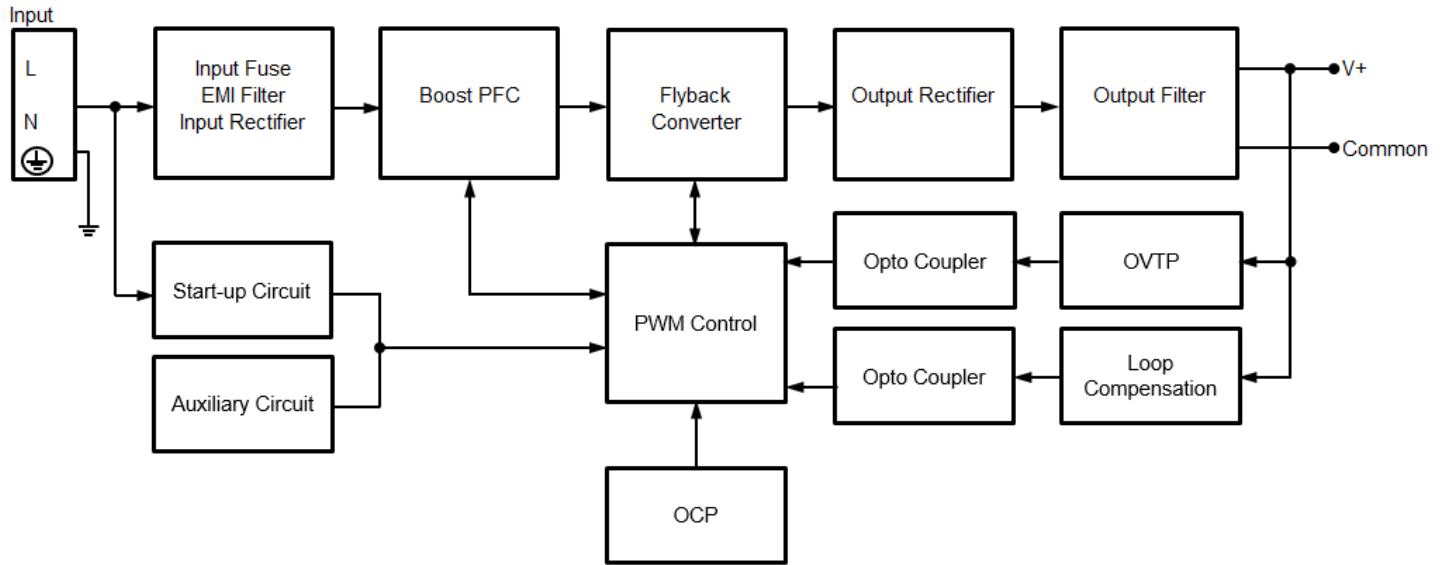

# PJL Open Frame Power Supply

## 48 V 400 W 1 Phase / PJL-48V400WBAA

### Dimensions

L x W x D: 127 x 76.6 x 39.3 mm [5.00 x 3.02 x 1.55 inch]

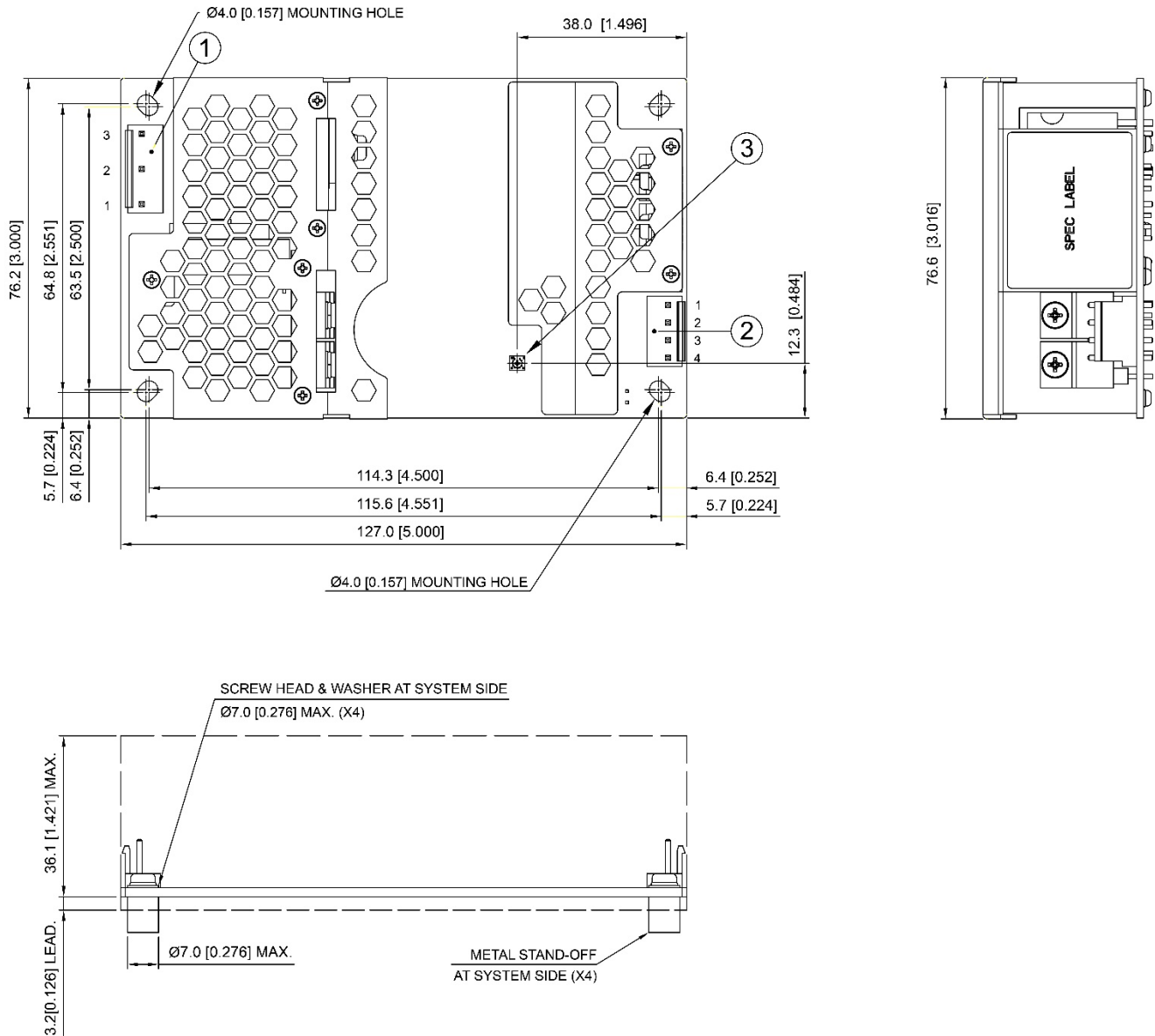

Item	Device Description
1	Input Connector (CN1) Pin 1: Line Pin 2: Neutral Pin 3: FG
2	Output Connector (CN2) Pin 1 to 2: V1(-) Pin 3 to 4: V1(+)
3	DC voltage adjustment potentiometer

# PJL Open Frame Power Supply

## 48 V 400 W 1 Phase / PJL-48V400WBAA

### Engineering Data

#### Installation of Forced Air

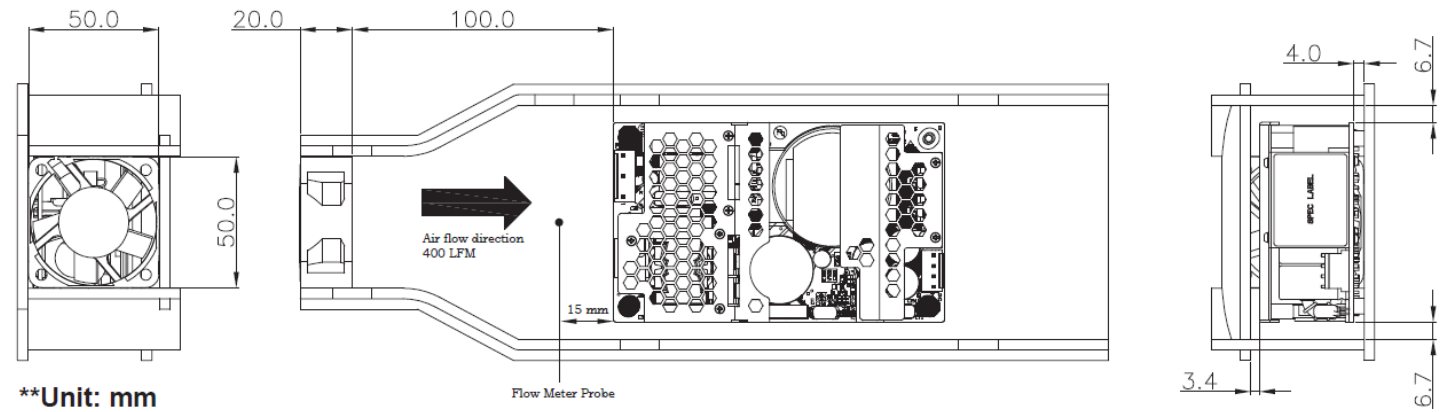

# PJL Open Frame Power Supply

## 48 V 400 W 1 Phase / PJL-48V400WBAA

### Mounting Orientation

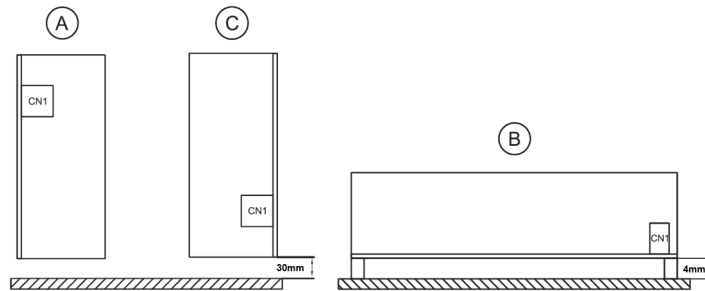

### Output Load De-rating VS Surrounding Air Temperature

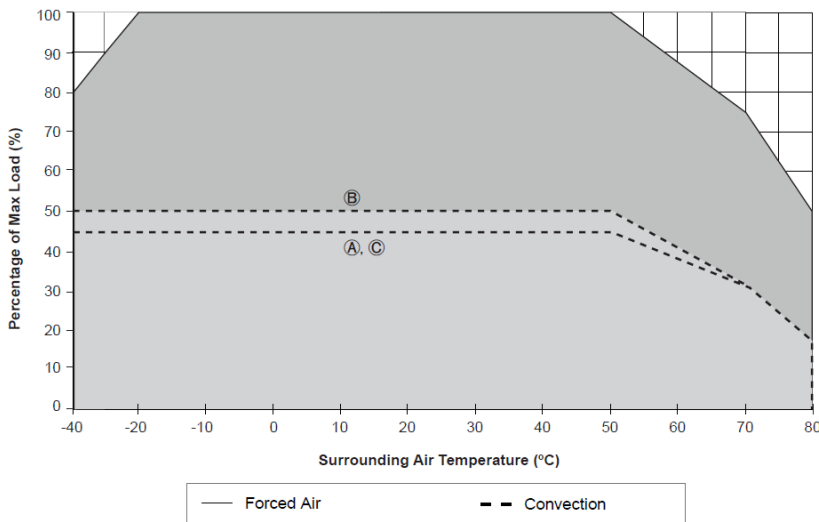

### Note

1. Power supply components may degrade, or be damaged, when the power supply is continuously used outside the shaded region, refer to the graph shown in Fig. 1.
2. If the output capacity is not reduced when the surrounding air temperature exceeds its specification as defined on Page 3 under "Environment", the device will run into Over Temperature Protection. When activated, power supply will latch off, until the surrounding air temperature is lowered or the load is reduced as far as necessary to keep the device in working condition, and require removal/re-application of input AC voltage in order to restart.
3. In order for the device to function in the manner intended, it is also necessary to keep a safety distance as recommended in the safety instructions while the device is in operation.
4. Depending on the surrounding air temperature and output load delivered by the power supply, the device can be very hot!
5. If the device has to be mounted in any other orientation, please contact [info@deltapsu.com](mailto:info@deltapsu.com) for more details.

Fig. 1 De-rating for All Recommended Mounting Orientation

Temperature	Power De-rating
<b>Fan cool</b>	> 50°C de-rate power by 5 W / °C > 70°C de-rate power by 10 W / °C (400 W @ 50°C, 350 W @ 60°C, 300 W @ 70°C, 200 W @ 80°C with 400 LFM fan cool) < -20°C de-rate power by 4W / °C (80% load at -40°C)
<b>Convection</b>	Convection A,C > 50°C de-rate power by 2.8 W / °C > 70°C de-rate power by 4.9 W / °C (180 W @ 50°C, 124 W @ 70°C, 75 W @ 80°C) Convection B > 50°C de-rate power by 3.8 W / °C > 70°C de-rate power by 4.9 W / °C (200 W @ 50°C, 124 W @ 70°C, 75 W @ 80°C)



# PJL Open Frame Power Supply

## 48 V 400 W 1 Phase / PJL-48V400WBAA

### Output Load De-rating VS Input Voltage

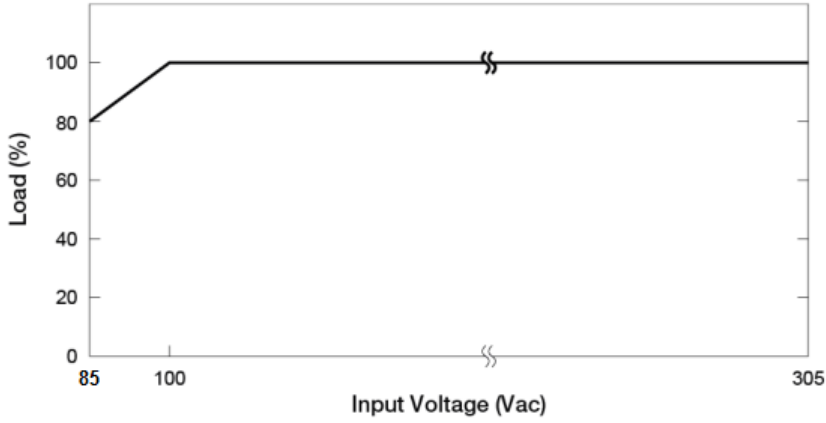

- No output power de-rating for the input voltage from 100 Vac to 305 Vac

# PJL Open Frame Power Supply

## 48 V 400 W 1 Phase / PJL-48V400WBAA

### Assembly & Installation

- Ⓐ Mounting holes for the open frame type of power supply<sup>1)</sup>.
- Ⓑ Mounting holes should be connected to the system's protective earth (PE)<sup>1)</sup>.
- Ⓒ This surface belongs to customer's end system or panel where the power supply is mounted.

1) Note: 4 x Ø3.5 mounting holes; Ø5.5 max dimension of screw head. Recommended mounting torque for tightening: 4-8Kgf.cm.

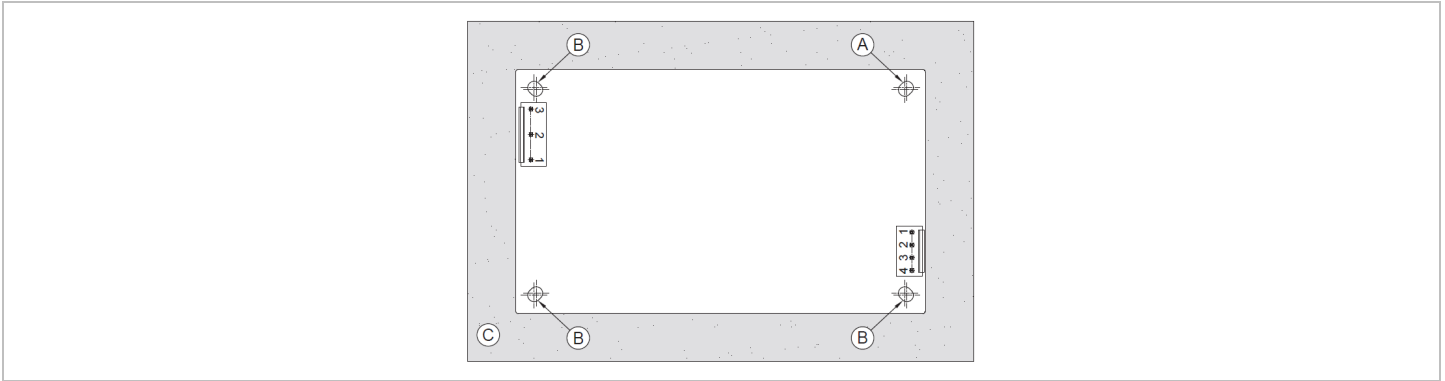

Fig. 2 Installation of the Device

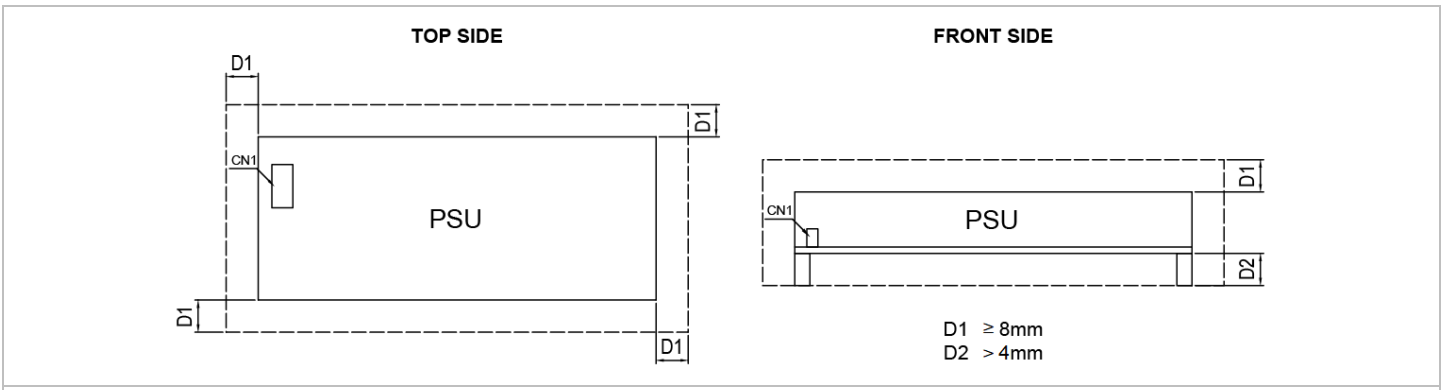

Fig. 3 Assembly Reference

- Any excessive twisting or bending may damage the device's PCB. Please handle the device with care.
- Please refer to Table 1 for the recommended Mating Connector, Terminal and AWG wire size.

Table 1	Power Supply Header	Mating Connector	Terminal	AWG
Input (TE)	1-1123724-3	1-1123722-5	1123721-1 or 1123721-2	18
Output (TE)	1-1123723-4	1-1123722-4		18

# PJL Open Frame Power Supply

## 48 V 400 W 1 Phase / PJL-48V400WBAA

### Safety Instructions

- The device is not recommended to be placed on surface with low thermal conductivity, such as plastics, for example.
- For safety reason, please ensure the mounted device is kept at  $\geq 8$  mm safety distance for D1 from other components and equipment; and  $\geq 4$ mm distance for D2. Please insert an insulation sheet between the system and product, if the safety distance is  $< 8$  mm for D2 (Refer to Fig. 3)
- Installation of forced air, to ensure sufficient air flow, always maintain a distance and air flow direction as recommended in installation of forced air.
- Note that the device can become very hot depending on the ambient temperature and load of the power supply. Do not touch the device while it is in operation or immediately after power is turned OFF. Risk of burning!
- Do not touch the terminals while power is being supplied. Risk of electric shock.
- Prevent any foreign metal, particles or conductors from entering the device through the openings during installation. It may cause: Electric shock; Safety Hazard; Fire; Product failure
- Warning: The power supply must be mounted by metal screws onto a grounded metal surface. It is highly recommended that the Earth terminal on the connector be connected to the grounded metal surface.

### External Input Protection Device

The unit is protected at the L pin, with an internal fuse that cannot be replaced. The power supply has been tested and approved on 20 A (UL) and 16 A (IEC) branch circuits without additional protection device. An external protection device is only required if the supplying branch has an ampacity greater than above.

# PJL Open Frame Power Supply

## 48 V 400 W 1 Phase / PJL-48V400WBAA

### Functions

■ Graph illustrating the Start-up Time, Rise Time, and Hold-up Time

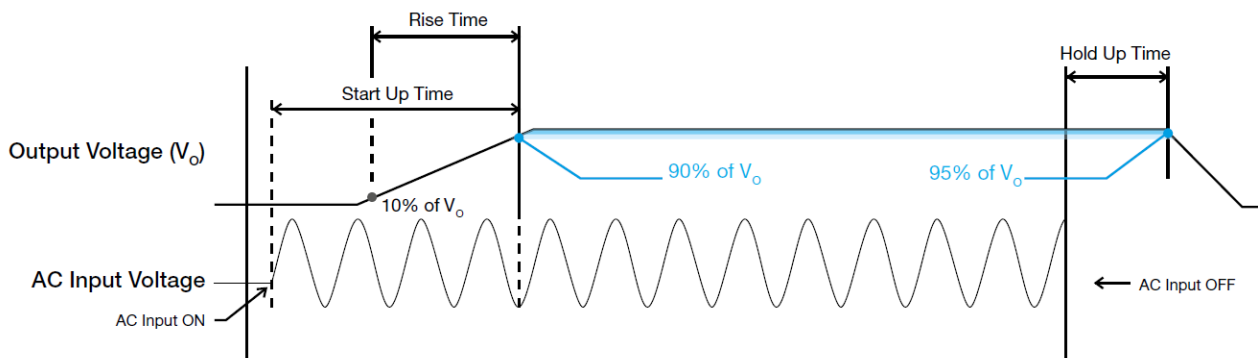

### Start-up Time

The time required for the output voltage to reach 90% of its final steady state set value, after the input voltage is applied.

### Rise Time

The time required for the output voltage to change from 10% to 90% of its final steady state set value.

### Hold-up Time

Time between the collapse of the AC input voltage, and the output falling to 95% of its steady state set value.

# PJL Open Frame Power Supply

## 48 V 400 W 1 Phase / PJL-48V400WBAA

### Inrush Current

Inrush current is the peak, instantaneous, input current measured and, occurs when the input voltage is first applied. For AC input voltages, the maximum peak value of inrush current will occur during the first half cycle of the applied AC voltage. This peak value decreases exponentially during subsequent cycles of AC voltage.

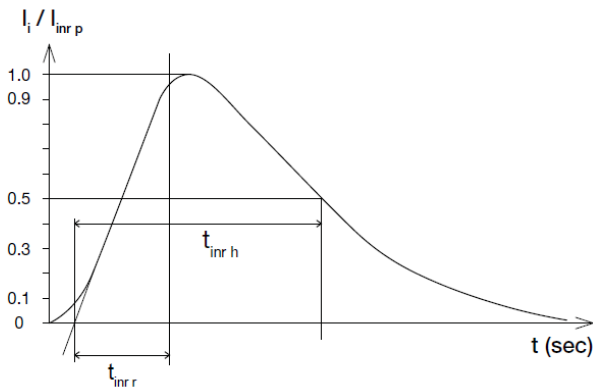

### Overload & Overcurrent Protections (Auto-Recovery)

The power supply's Overload (OLP) and Overcurrent (OCP) Protections will be activated when either output's current exceeds its specification as defined on Page 3 under "Protections". In such occurrence, the output voltage will start to droop and once the power supply has reached its maximum power limit, the protection is activated and the power supply will go into "Hiccup mode" (Auto-Recovery). The power supply will recover once the fault condition of the OLP and OCP is removed and  $I_o$  is back within the specifications.

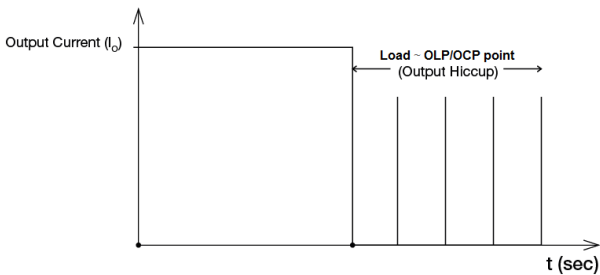

It is not recommended to prolong the duration of  $I_o$  when it is less than OLP/OCP point, but greater than 100%, since it may cause damage to the PSU.

### Short Circuit Protection (Auto-Recovery)

The power supply's output OLP/OCP function also provides protection against short circuits. When a short circuit is applied, the output current will operate in "Hiccup mode", as shown in the illustration in the OLP/OCP section on this page. The power supply will return to normal operation after the short circuit is removed.

### Dynamic Response

The power supply output voltage will remain within  $\pm 5\%$  of its steady state value, when subjected to a dynamic load from 0% to 100% of its rated current.

#### ■ 50% duty cycle / 5 Hz to 1 KHz

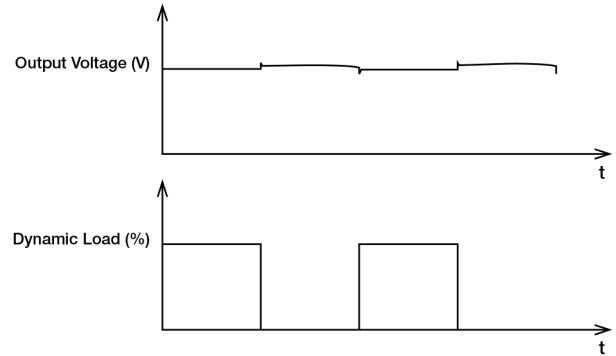

### Overvoltage Protection (Latch Mode)

The power supply's overvoltage protection circuit will be activated when its internal feedback circuit fails. The output voltage shall not exceed its specifications defined on Page 3 under "Protections". Power supply will latch off, and require removal/re-application of input AC voltage in order to restart.

#### The power supply should be latch

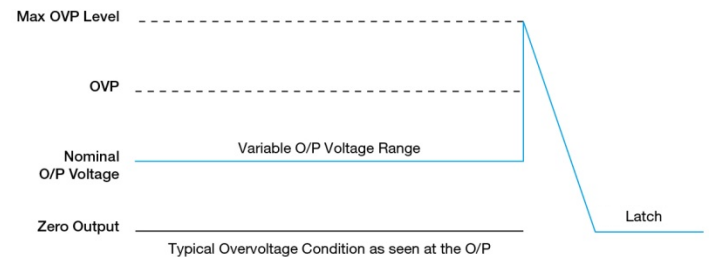

### Over Temperature Protection (Latch Mode)

As described in load de-rating section, the power supply also has Over Temperature Protection (OTP). In the event of a higher operating temperature at 100% load; or, when the operating temperature is beyond what is recommended in the de-rating graph, the OTP circuit will be activated. When activated, power supply will latch off, until the surrounding air temperature drops to its normal operating temperature or the load is reduced as recommended in the de-rating graph. Removal/re-application of input AC voltage will then be required in order to restart.

# PJL Open Frame Power Supply

## 48 V 400 W 1 Phase / PJL-48V400WBAA

### Others

#### PFC – Norm EN 61000-3-2

##### Line Current Harmonic content

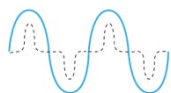

Typically, the input current waveform is not sinusoidal due to the periodical peak charging of the input capacitor. In industrial environment, complying with EN 61000-3-2 is only necessary under special conditions. Complying to this standard can have some technical drawbacks, such as lower efficiency as well as some commercial aspects such as higher purchasing costs. Frequently, the user does not profit from fulfilling this standard, therefore, it is important to know whether it is mandatory to meet this standard for a specific application.

### Attention

Delta provides all information in the datasheets on an “AS IS” basis and does not offer any kind of warranty through the information for using the product. In the event of any discrepancy between the information in the catalog and datasheets, the datasheets shall prevail (please refer to [www.DeltaPSU.com](http://www.DeltaPSU.com) for the latest datasheets information). Delta shall have no liability of indemnification for any claim or action arising from any error for the provided information in the datasheets. Customer shall take its responsibility for evaluation of using the product before placing an order with Delta.

Delta reserves the right to make changes to the information described in the datasheets without notice.

### Manufacturer and Authorized Representatives Information

#### Manufacturer

##### Thailand

Delta Electronics (Thailand) PCL.  
909 Pattana 1 Rd., Muang, Samutprakarn, 10280 Thailand

##### Taiwan

Delta Electronics, Inc.  
3 Tungyuan Road, Chungli Industrial Zone, Taoyuan County  
32063, Taiwan

#### Authorized Representatives

##### The Netherlands

Delta Greentech (Netherlands) B.V.  
Zandsteen 15, 2132 MZ Hoofddorp, The Netherlands

##### United Kingdom

Delta Electronics Europe Limited  
1 Redwood Court, Peel Park Campus,  
East Kilbride, Glasgow, G74 5PF, United Kingdom